

Étude Manual

V.1.0

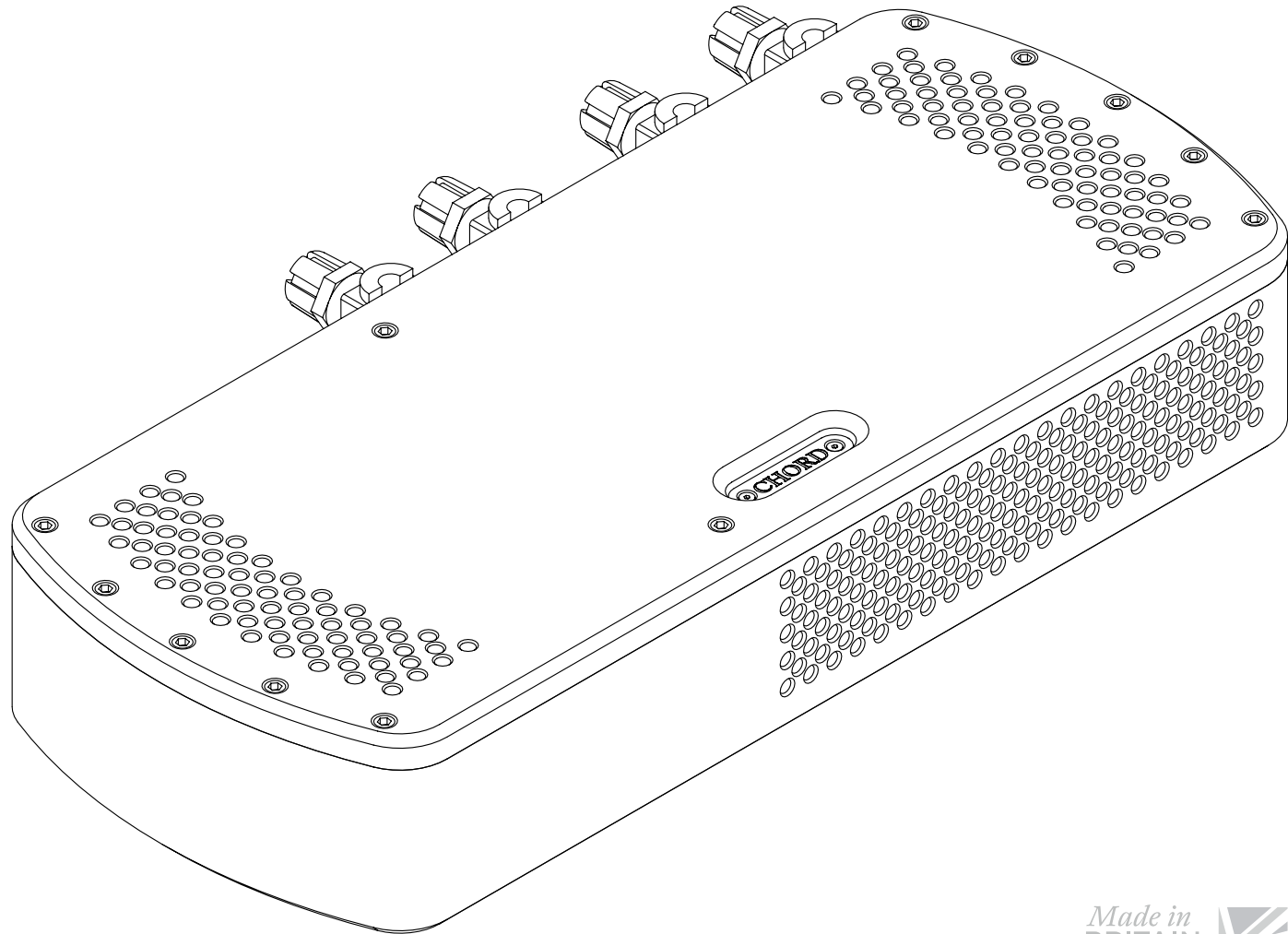



Chord Electronics Ltd.

THIS IS PURE AUDIO

Contents

0.0

1.0 Safety instructions	07
1.1 Introduction	08
1.2 Protection against liquids & heat	09
1.3 Dismantling & Radio frequency interference	10
1.4 Connecting your equipment	11

2.0 Warranty	13
2.1 Warranty period & registering your purchase	14
2.2 Making a claim & warranty exclusions	15

3.0 Getting to know Étude	17
3.1 Getting to know Étude	18
3.2 The front panel	19
3.3 The top panel	20
3.4 The rear panel	21

4.0 Setting up Étude	23
4.1 Placement	24
4.2 Connecting Étude to ancillary equipment	25
4.3 Line level inputs	26
4.4 Audio outputs	27
4.5 Power-on sequence	28
4.6 Earthing issues in Europe	29

5.0 Special features	31
5.1 Bridged operation & set-up	32
5.2 Notes	34

0.0 Contents

Safety instructions

1.0

- 1.1 Introduction
- 1.2 Protection against liquids & heat
- 1.3 Dismantling & Radio Frequency interference
- 1.4 Connecting your equipment

1.0 *Safety instructions*

Introduction

1.1



Étude is an incredibly dynamic next-generation power amplifier which uses a brand new analogue amplifier topology, Chord Electronics' first all-new design since its inception.

Before operation, we strongly advise that you read this user manual thoroughly, storing it in a safe place along with your original receipt of purchase, in case you should require assistance in the future.



 *Made in* **BRITAIN**

Protection against liquids & heat

1.2



The Étude is not protected against liquids of any kind. Never place containers of liquid on Étude. Never allow Étude to come into contact with moisture or liquids; doing so could result in electrocution or damage to the Étude's internal circuitry.

Be aware that liquids, including water that has dried, can leave minerals that can affect the PCB and other components, which could eventually lead to oxidisation and short-circuiting.

If the Étude comes into contact with moisture or liquids, immediately disconnect from the mains power supply, and connected equipment, and contact Chord Electronics for further advice.



The Étude has internal thermal protection which will increase the speed of the cooling fans if excessive temperatures are being reached. Should this occur then check that Étude has adequate ventilation and/or reduce the volume level until Étude has cooled and the fans slowed.

Never operate the Étude near sources of heat or naked flames as this will decrease the lifespan of the internal components. It is advised that you do not operate the Étude in an area of direct sunlight or on top of significant heat-producing devices.

Please be aware that it is entirely normal for the Étude to become warm during use, particularly within a stacked configuration. If you are concerned about the temperatures, please switch the device off and consider a different placement.

Dismantling & radio frequency interference

1.3



There are no user-serviceable components within the Étude or its power supply. Dangerous voltages/currents exist within the Étude and its power supply, posing a severe risk of electrocution and/or fire.



Never attempt to open, dismantle or apply internal third-party devices to it or insert anything other than the listed interconnects or speaker cables within this user manual.

If the Étude develops a fault or the casework becomes damaged, immediately disconnect from the mains power supply and connected equipment and contact Chord Electronics for further advice.

With a thick, solid aluminium chassis, the Étude's casework largely protects the sensitive internal circuitry from radio frequency interference. However, for optimal performance, it is recommended that the following points are observed:



1. Consider placing the Étude away from wireless routers.



2. Separate the Étude from amplifiers using toroidal transformers.



3. Operate mobile phones at a distance to avoid interference.



Although the Étude is largely shielded, it can generate radio frequency interference that may have an effect on radio and television reception. If this occurs, please reconsider your placement.

Connecting your equipment

1.4

Before connecting the Étude to any equipment, consult the manufacturer's user guide to confirm compatibility.

When connecting the Étude to any equipment, make sure that all devices are off, including the Étude. Once connected, switch all equipment on starting with the source and ending with the amplification. Initially, operate the Étude with your preamp/device on its lowest gain setting and lowest volume setting, gently increasing to a comfortable listening level. Never operate the Étude at excessive sound levels; permanent hearing damage and loss can occur.

Étude is supplied with its own grounded 10A-rated mains IEC cable and it is important that the amplifier is earthed at all times via this cable, or an appropriate alternative. Failure to do this could be hazardous in the unlikely event of a fault. Étude employs an auto-sensing mains input voltage circuit and will adjust to suit your region's supply; Étude will operate between 120V AC and 240V AC -50Hz - 60Hz. Étude is fully protected in the event of a short circuit or fault and will automatically shut down.

Étude's supplied region-specific 10A mains IEC cable can be supplemented for an alternative power cable, however, please make sure that it has an earth. If any cable becomes damaged you must discontinue use and replace it immediately to avoid the risk

of electrocution.

Étude must be permanently connected to a source of power. The included mains lead simply plugs into the Étude's IEC mains socket. If the mains lead is prematurely disconnected Étude may still remain active for up to 15 minutes.



WARNING: Never disconnect the power cable during operation. Only disconnect when Étude is off. If the power cable is disconnected during operation there is a risk of damage to connected equipment.



Warranty

2.0

- 2.1 Warranty period & registering your purchase
- 2.2 Making a claim & warranty exclusions

2.0 *Warranty*

Warranty period & registering your purchase

2.1

At point of sale, Chord Electronics Ltd. provides the Étude with a comprehensive five-year warranty* which covers defects in materials and workmanship through fair wear and tear.

*The warranty is transferable with proof of purchase, however is not available on ex-demonstration products.



Please use the form below to record the details of your purchase in the event that these are required at a later date, we further advise that all purchases are registered with Chord Electronics at: chordelectronics.co.uk/register-product/

RETAILER:	
UNIT COLOUR:	
DATE OF PURCHASE:	
TRANSACTION ID:	

Making a claim & warranty exclusions

2.2

In the unlikely event of a claim, you must provide Chord Electronics with the details of the claim, including your original proof of purchase and serial number in order to validate the nature of the repair.

Upon receipt, Chord Electronics will make an assessment within 30 days and provide a reasonable solution.

All warranty repairs must be carried out by Chord Electronics or an approved service centre to guarantee the quality and safety of the repair.

WARRANTY EXCLUSIONS: The warranty does not cover connected equipment, personal injury or development natural patina of the metalwork and will be null and void if the following is applied: wilful neglect; modification or tampering of the product; improper use of the product; acts of God; damage caused by a connected device; mechanical shock; fire or application of excessive heat or repair/modification by a non-authorized third-party vendor.

Getting to know Étude

3.0

3.1 Getting to know Étude

3.2 The front panel

3.3 The top panel

3.4 The rear panel

3.0

Getting to know Étude

Getting to know Étude

3.1

Étude is an incredibly dynamic next-generation power amplifier which uses a brand new analogue amplifier topology, Chord Electronics' first all-new design since its inception. Before operation, we strongly advise you read this user manual thoroughly, storing it in a safe place along with your original receipt of purchase, should you require assistance in the future.



The front panel

3.2

Étude has no user-controlled buttons on the front panel and simply features a ventilation system integrated into the casework.



 **WARNING:** You must keep all vents clear.

The top panel

3.3

Similar to the front panel, the top panel of the device also has no user-controlled buttons and simply features two ventilation systems integrated into the casework.



 **WARNING:** You must keep all vents clear.

The rear panel

3.4

The rear panel offers a comprehensive connectivity suite, featuring both balanced and unbalanced inputs for connection to preamps and audiophile-grade 30-amp loudspeaker binding terminals, suitable for use with banana- and spade-type speaker plugs.

The rear panel also features the IEC mains input for use with the supplied power cable, an on/off single analogue rocker switch and a phase toggle switch for each channel.



 **WARNING:** You must keep all vents clear.

Setting up Étude

4.0

- 4.1 Placement
- 4.2 Connecting Étude to ancillary equipment
- 4.3 Line level inputs
- 4.4 Audio outputs
- 4.5 Power-on sequence
- 4.6 Earthing issues in Europe

4.0

Setting up Étude

Placement

4.1

Whilst Étude will operate normally within a stack of other Chord Electronics Choral components within the Choral Ensemble stand/floor system, it is recommended that the device is allowed to 'breathe' with 10cm of space around it to convection-cool during operation.

For this reason we recommend the Chord Electronics Ensemble stand, as shown.



Connecting Étude to ancillary equipment

4.2

When connecting the Étude to equipment within the signal path, ensure all devices are switched off. It is recommended that once all equipment is properly connected, that the volume setting is operated to its lowest setting, before slowly being raised to a comfortable listening level. Always observe partnering manufacturers' guidelines.

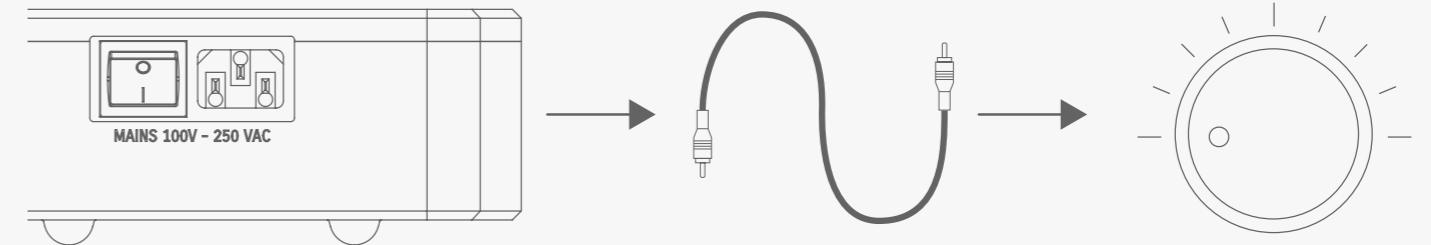

Line level Inputs

4.3

Étude is equipped with a stereo pair of unbalanced (single-ended) RCA inputs and a stereo pair of balanced XLR inputs. Étude has no ability to switch between the inputs, therefore, only one must be used. Connect the left and right line input channels on Étude with the corresponding line outputs on your preamp or device and double-check.

Étude also features a phase toggle switch for each channel. In normal stereo mode where one power amplifier is being used, both toggle switches should remain in the same 'down' position. The amplifier can also be used in bridged mode, requiring an alternative phase switch position; details on this and bridging mode can be found further on under Special Features.

WARNING: Étude must be connected to a dedicated preamplifier, or a device capable of attenuating its output. Failure to attenuate the volume before it enters Étude could result in irreversible hearing damage, speaker damage and could void the warranty.



Audio outputs

4.4

Étude supports a single stereo output. In order to connect Étude to loudspeakers, use high-quality loudspeaker cable terminated with 4mm banana plugs or 6mm spades. Bare wire can be used, but it is not recommended.

Connect the black (negative) terminal from Étude to the negative terminal on your loudspeaker and the red (positive) terminal from Étude to the red positive terminal on your loudspeaker. Repeat for each channel.



Power-on sequence

4.5



With the unit connected to a mains power supply, switch Étude 'on' using the analogue rocker switch located next to the mains input. This will switch the unit both on and off. During the initial start-up phase, Étude will power-up and perform a safety check.



Once complete (after approximately twelve seconds), the relays will engage and the output will be live, with the internal LEDs glowing blue.

If a fault is detected the unit will simply switch itself off. As Étude consumes very little power when idle, we recommend leaving the unit switched 'on' when not in use.

Earthing issues in Europe

4.6



In some European countries, a hum or buzz may occur if the amplifier is connected to mains sockets that do not have an earth or adequate earth. If this occurs, please ensure that your equipment is connected via a good-quality multi-way mains block which contains an earth point at every socket outlet.

We recommend that an earthing method for your building is implemented.

Special features

5.0

5.1 Bridged operation & set-up

5.2 Notes

5.0 *Special features*

Bridged operation & set-up

5.1

Although the amplifier is conservatively rated at 150W into 4Ω, Étude can be operated in bridged mono mode, increasing power to 300W into 4Ω. The bridged mono configuration allows two separate Étude power amplifiers to be used in a system, each feeding a separate loudspeaker. In this manner, each power amplifier only carries the signal for the left or right channel of audio. This ensures that cross-talk distortion or interference that may normally occur between the left and right channels is completely eliminated.

SET-UP: To initiate bridged operation with two Étude power amplifiers take two balanced (or RCA) outputs from the pre-amplifier or device on one channel only i.e. output 1 left channel and output 2 left channel and plug these into the balanced inputs on the first Étude. Plug one loudspeaker across the red speaker terminals only (one red post is on the left output and one red post is on the right output). This will now be bridged. Repeat the process with the second Étude for the right channel, making sure all the connections are identical as for the left channel. Connect the output 1 right channel and output 2 right channel of the pre-amplifier to the balanced inputs of the second Étude. As before, connect the second loudspeaker across the red speaker terminals only.

BRIDGED OPERATION AND PHASE SWITCHING: Étude's phase toggle switch is capable of changing the absolute phase; positive (in phase) is 'up', negative (out of phase) is 'down'. To correctly use the amplifier(s) in bridged mode, each input must have the opposite phase: one switch must be in the 'up' position, whilst the other one must be down. It doesn't matter which switch is up or down, just that they are opposite. It's important to ensure that the second amplifier in the bridged system, has exactly the same phase switch settings.

Note 1: if you are using a pre-amplifier or device with only one balanced output you'll need to use two balanced 'Y' leads to connect, feeding both channels of one Étude amplifier with the same signal i.e. either right or left. You only use the two red terminals when bridged. So right red (+) remains as is and left red (+) becomes Right return (-) or black in the case of most speaker cables.

CAUTION: with the increased power output available from bridged mode, please take extra precaution when connecting the Études to equipment within the signal path, ensuring all devices are switched off and that the volume setting is operated to its lowest setting, before slowly being raised to a comfortable listening level.

Bridged operation & set-up

5.1

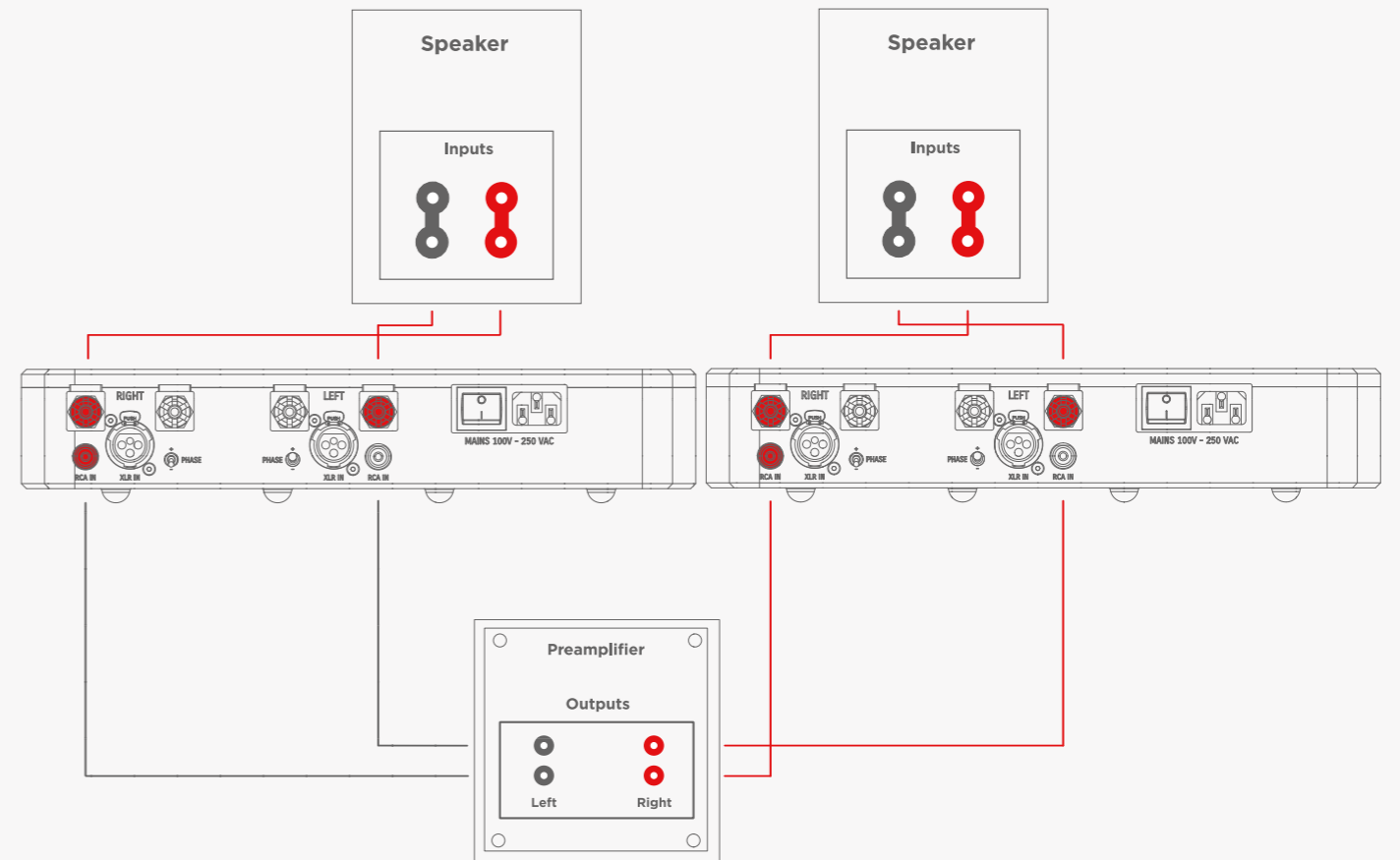

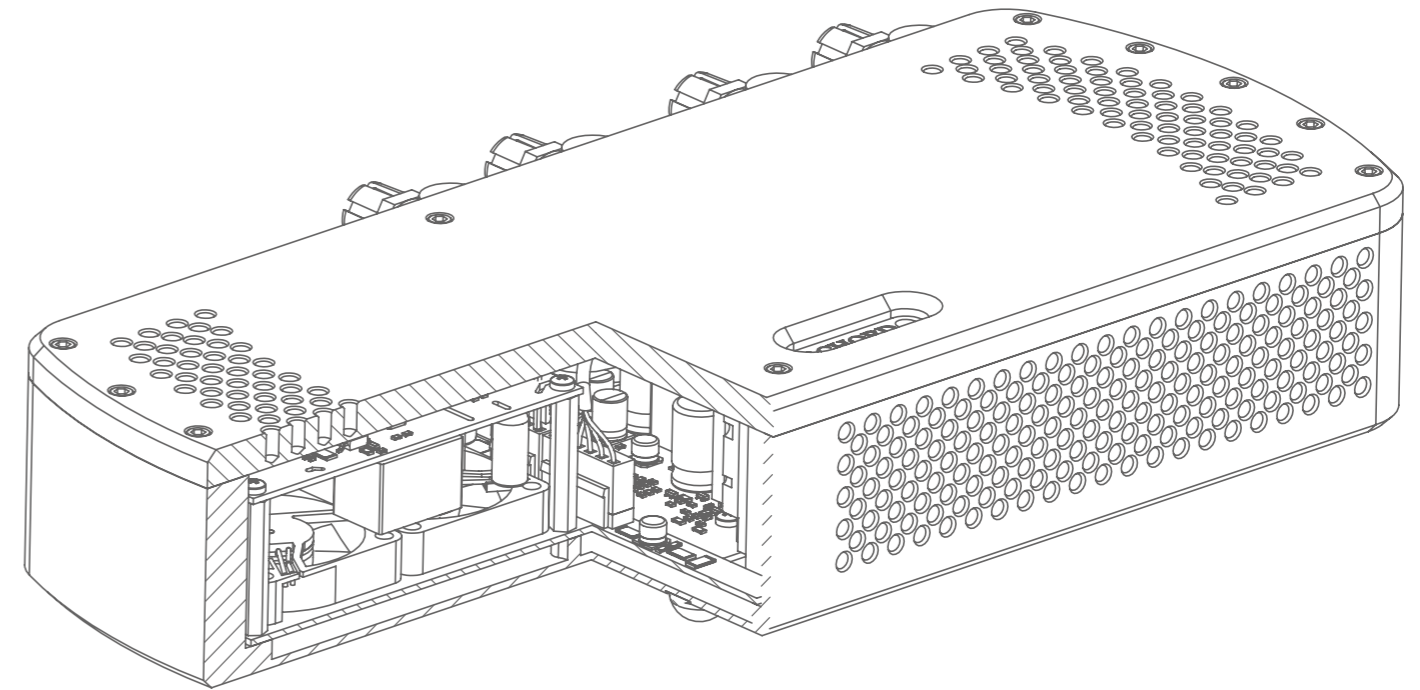
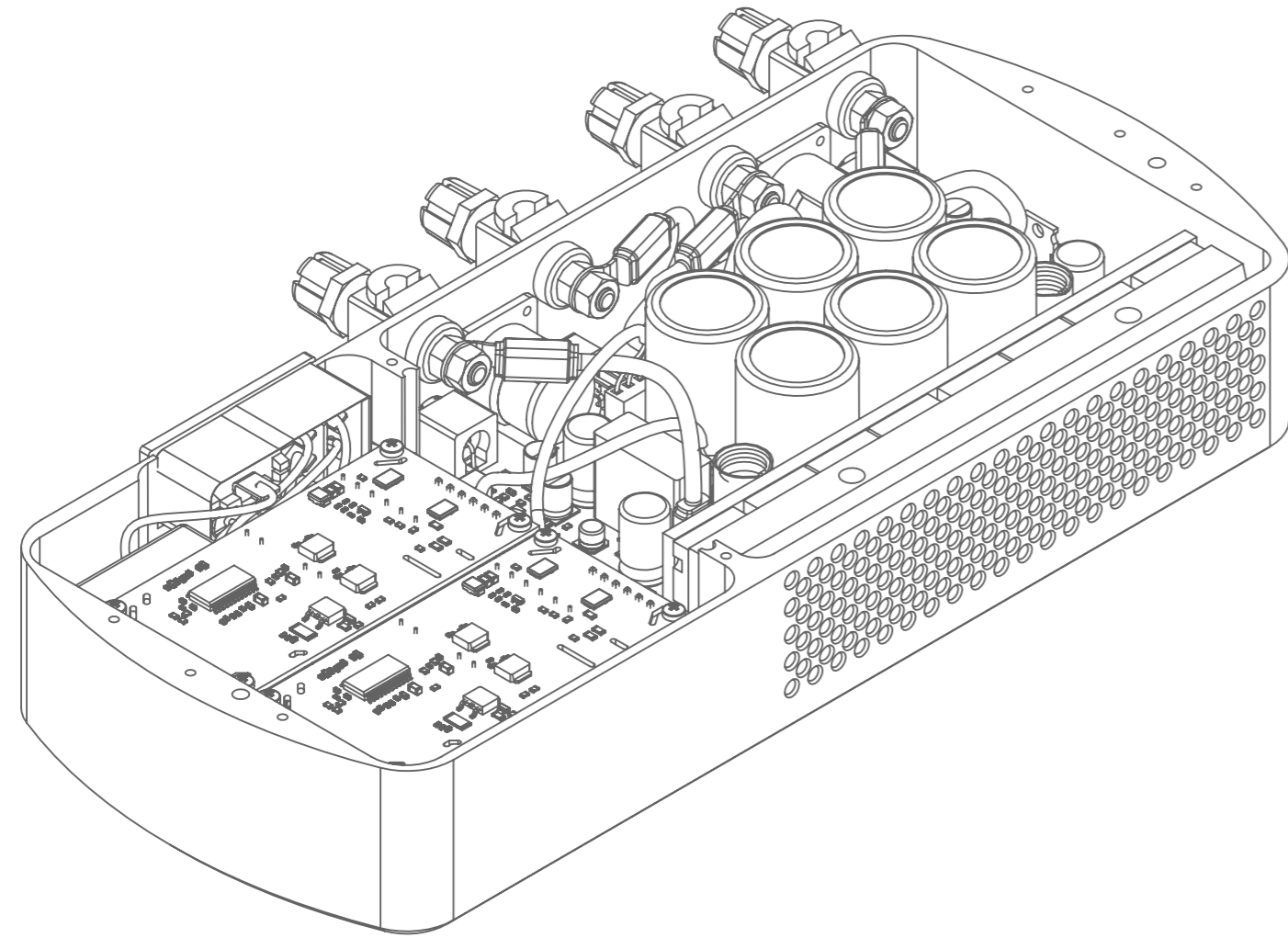



Chord Electronics Ltd.

THIS IS PURE AUDIO



Chord Electronics Ltd.

